



T302X high performance load cell

Technical Specification



DESCRIPTION

General

A hermetically sealed load bearing unit operating in compression to produce an analogue output which is proportional to the applied load. Construction is 100% stainless steel, natural finish.

- New improved compact design
- Built to last – robust design
- Quality assured
- IP69K ideal for harsh environments
- Outstanding accuracy & performance
- Built-in lightning protection
- Retrofittable design
- Affordable
- Accuracy 5000d as standard
- 100% stainless steel construction
- 25 metre cable length

Available Capacities

- 22.5 tonne
- 45 tonne

Special Features

4x50GΩ Surge arresters fitted internally to provide protection against lightning damage.

Supplied ready-assembled with gaiters and load buttons for simple installation.

Unlike other canister loadcells on the market today, all T302X loadcells will be supplied as standard with pre-greased top and bottom load buttons. This helps protect the load cell from harsh environments and helps to reduce load cell rotation.

Custom designed to obtain the optimum electrical balance properties required for high accuracy weighing applications in industrial environments.

Backward comparable – Being smaller means the new T302X can be used to directly replace old T302 with the aid of a retrofit adaptor block to take up the gap between the base location and the bottom of the canister loadcell.

The T302X is also fully compatible with the 8701 for both approved and non approved applications.

OIML R60 approved to 5000d and available in 22.5 tonne and 45 tonne capacities.

Fitted with a 25 metre 4 wire 7 x 0.12mm core cable that has an electrically, mechanically and chemically tough polyurethane sheathed cable for added protection.

APPLICATIONS

This transducer is designed to operate with loads applied through the central axis of the cell. For high accuracy weighing applications, the load cell is protected from side forces and/or off centre loads by mounting it as a double pendle (strut) unit. The T302X allows the weighbridge to travel the same distance as the T302 making this an ideal T302 replacement. Tie bars or bumper stops will be required to help restrict horizontal movement of the load platform when in use. Due to its anti-rotation design, the T302x can be used either way up.

Retrofit existing load cells

A T302x Retrofit option has been produced to enable the T302x to quickly and easily be used to replace other manufacturers' canister load cells without making any major bridge modifications. (Shown on page 3).

T302X (Retrofit option A) 22.5T with 25m cable:
Part number: AWT05-053876

T302X (Retrofit option A) 45T with 25m cable:
Part number:AWT05-05387

Typical Vehicle Weighing Applications

In the weighbridge application shown below, the strut unit provides the cell with the optimum loading conditions needed for high accuracy vehicle weighing.

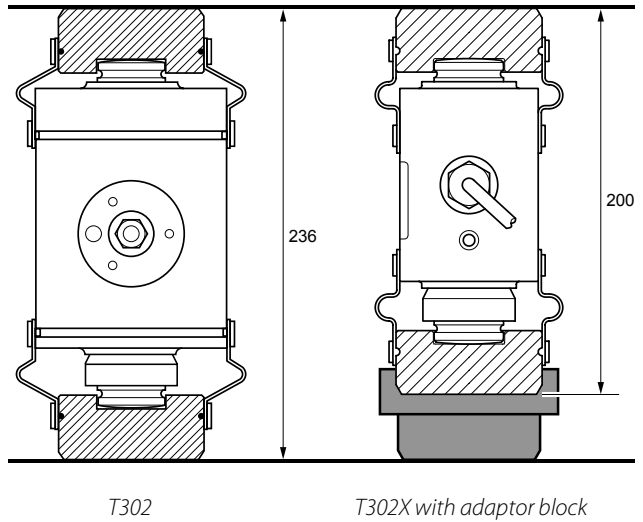

T302 replacement

When a replacement unit is required, the new T302X has been designed to fit directly into the same loadcell location with the aid of a retrofit adaptor block. (Shown above).

T302 to T302X adaptor block
Part number: AWT20-001378

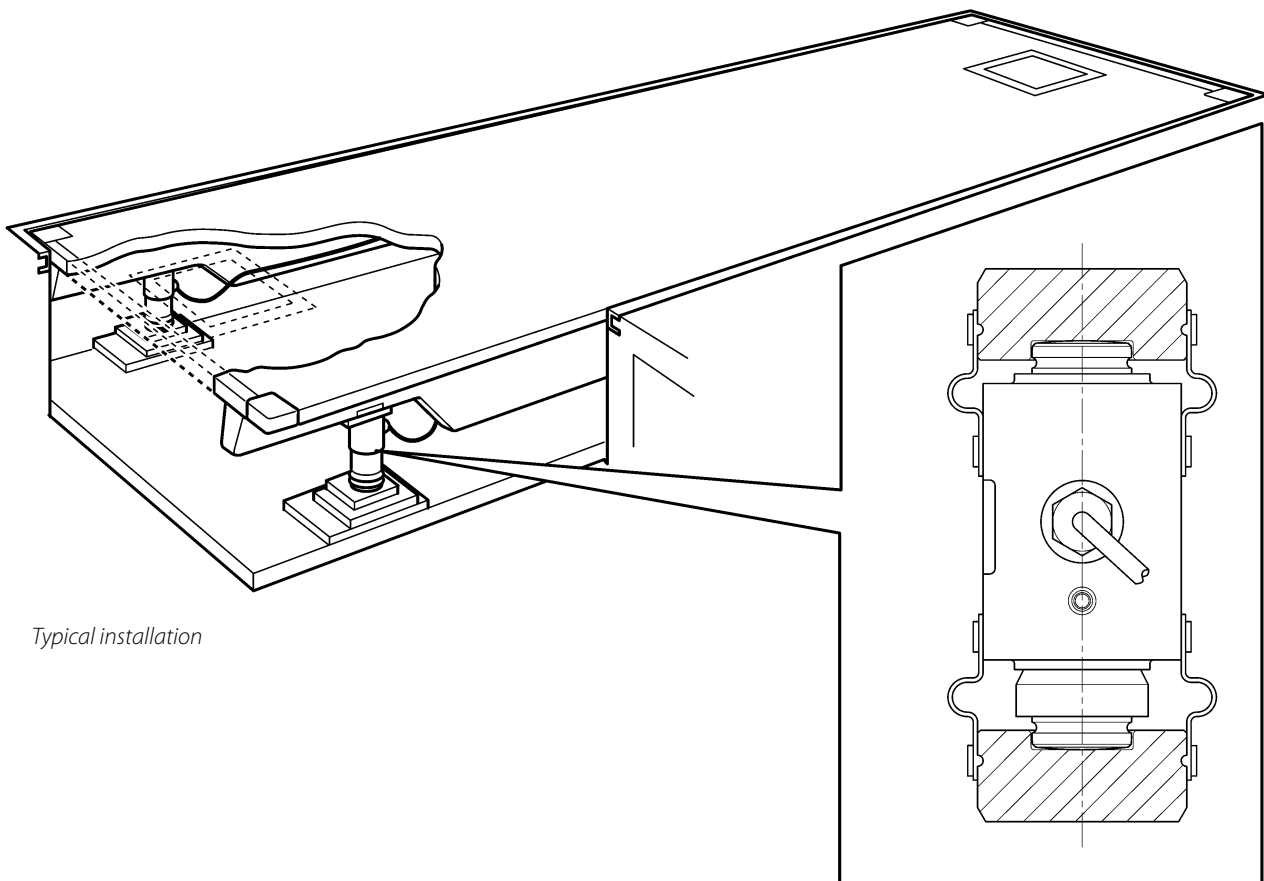

Typical installation



DIMENSIONS

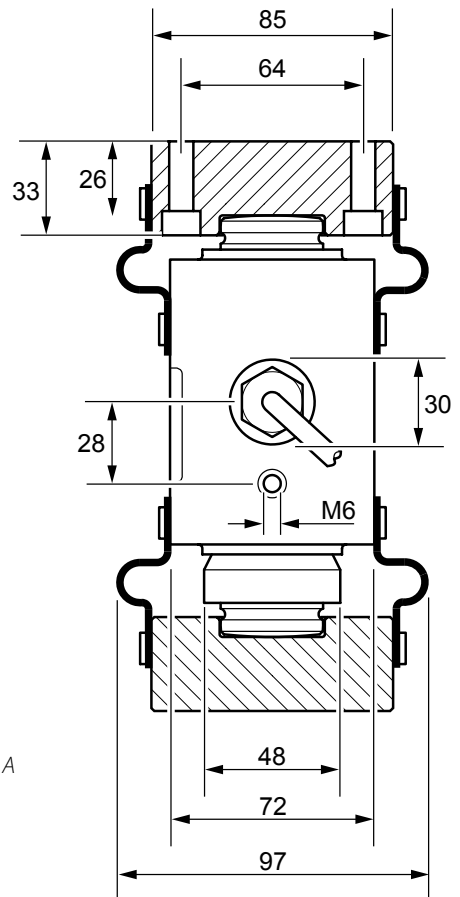
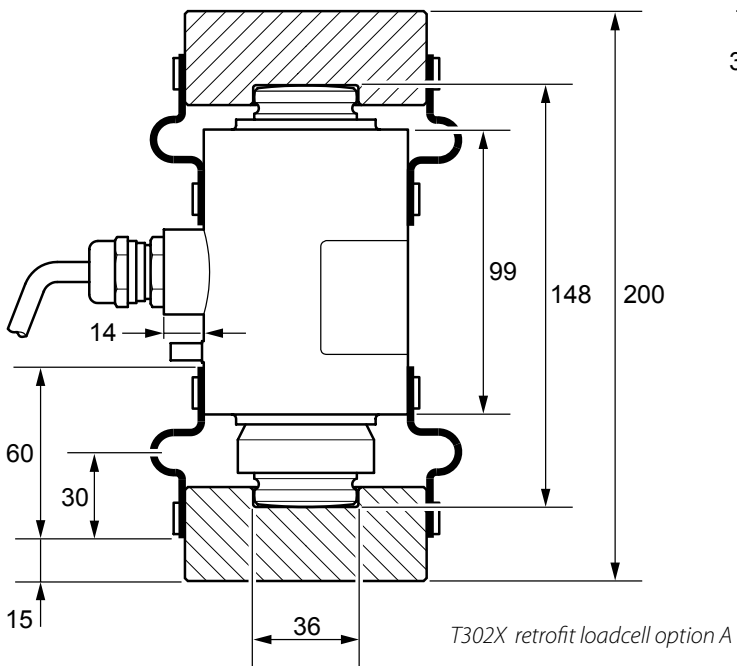
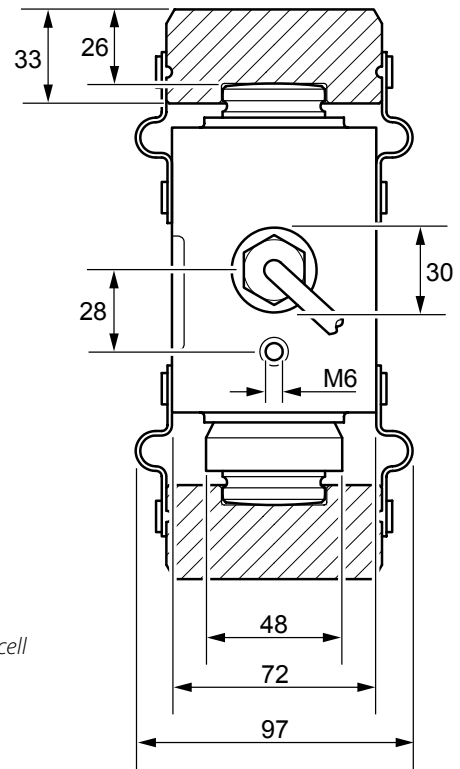
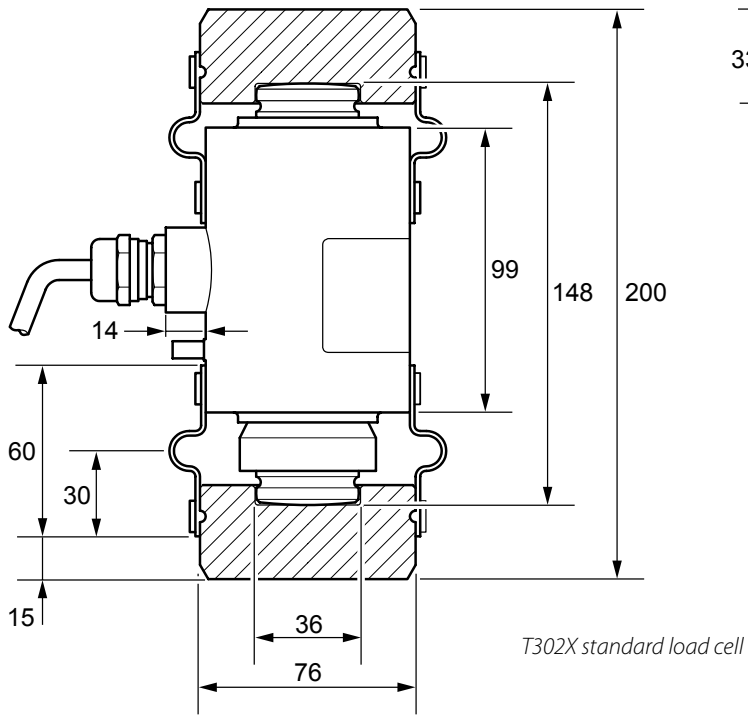



SPECIFICATIONS

Environment

Resistance to Dirt & Moisture

The load cell has been designed to exceed IP69K rating.

Electrical Disturbance

Immune to electrical disturbance, including RFI as detailed in EN45501:1992.

Storage Temperature Range

- 30° C to + 85° C

Operating Temperature Range

- 20° C to + 60° C

Calibrated Temperature Range

- 10° C to + 40° C

Approvals

OIML approval 5000d

Certificate number: R60/2000-GB1-09.10

The T302X has been added on to all AWTX OIML approval indicator certificates to allow the T302X to be individually used as a direct replacement for any T302 used out in the field.

Electrical

Electrical Termination

4 core 7 x 0.12 mm or equivalent.

Standard length 25 metres.

Outer tinned copper sheath.

Input: Black - Green +

Out put: Red - White +

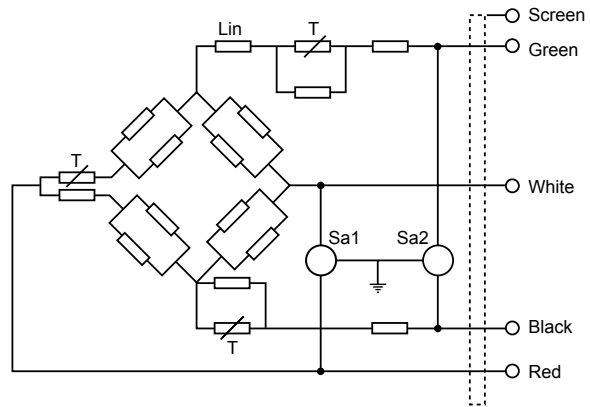

Excitation Electrical (Recommended)	10 - 12 v, AC or DC
Excitation Electrical (Maximum)	20 v, AC or DC
Terminal Resistance Input at 20° C	560 - 620
Terminal Resistance Output at 20° C	480 Nominal
Rated Output	1.75 mV/V 0.1% (at rated capacity)
Zero Balance	1% of Rated Output
Combined Error	0.013% of Rated Output
Repeatability	0.01% of Rated Output
30 min Creep and Zero Return (OIML R60)	0.01% of Rated Output
Temperature Effect on Rated Output (-10° C to + 40° C)	0.0008%/° C
Temperature Effect on Zero Balance (-10° C to + 40° C)	0.0009%/° C
Overload Rating (Without affecting performance)	150% Rated Capacity
Overload Rating (Ultimate)	>225% Rated Capacity
Insulation Resistance (Minimum)	>5,000 M

Avery Weigh-Tronix - UK
 Foundry Lane, Smethwick,
 West Midlands B66 2LP UK
 info@awtxglobal.com
 Phone: +44 (0)845 3 66 77 88
 Fax: +44 (0) 121 697 5660

Avery Weigh-Tronix - USA
 1000 Armstrong Drive,
 Fairmont, MN 56031-1439 USA
 usinfo@awtxglobal.com
 Toll-Free: (800) 533-0456
 Phone: (507) 238-4461

Please call us or visit www.averyweigh-tronix.com
 for your nearest Avery Weigh-Tronix distributor

Avery Weigh-Tronix

